

GXR Wave

ALPHA BIDET

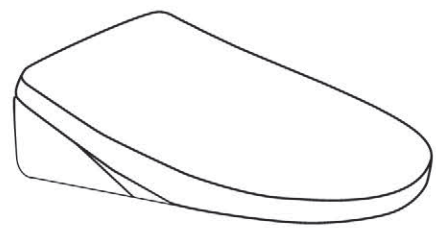

USER MANUAL

MODEL NUMBER	
GXR-Wave-EW (Elongated) GXR-Wave-RW (Round)	
NOTES	
<ul style="list-style-type: none"> This product was manufactured for household use only. Read all operating instructions before installation and use. Please save this operating instruction manual and place in an easily accessible location. Due to ongoing product improvements, external appearance and specifications are subject to change without notice. 	
CONTENTS	
Important Safeguards	02
Grounding Instructions	04
Parts Identification	05
Installation Instructions	06
Functions and Operation	09
Maintenance	10
Troubleshooting	12
Specifications	14
Warranty	15

IMPORTANT SAFEGUARDS

READ ALL INSTRUCTIONS BEFORE USING.

DANGER To reduce the risk of electrocution.

- Do not use while bathing.
- Do not place or store product where it can fall or be pulled into a tub or sink.
- Do not place in or drop into water or other liquid.
- Do not reach for a product that has fallen into water. Unplug immediately.

WARNING To reduce the risk of burns, electrocution, fire or injury to persons.

- If the supply cord is damaged, it must be replaced by the manufacturer, its service agent or similarly qualified persons in order to avoid a hazard.
- Connect this product to a properly grounded outlet only.
- Unplug the appliance during filling and cleaning.
- Do not touch the power plug with wet hands.
- Properly connect the power cord to the electrical outlet corresponding to the rated voltage of the unit.
- Keep the cord away from heated surfaces.
- Do not use damaged or loose power cord.
- Before removing the unit from the toilet bowl, disconnect the power plug first.
- Do not connect other electrical appliances to the same power socket connected to the unit.
- Children should be supervised to ensure that they do not play with the appliance.
- This appliance is not intended for use by persons (including children) with reduced physical, sensory or mental capabilities, or lack of experience and knowledge, unless they have been given supervision or instruction concerning use of the appliance by a person responsible for their safety.
- Never operate this product if it has a damaged cord or plug, if it is not working properly, if it has been dropped or damaged, or dropped into water.
- Return the product to a service center for examination and repair.
- Never block the air openings of the product or place it on a soft surface, such as a bed or couch, where the air openings may be blocked.
- Keep the air openings free of lint, hair, and the like.
- Any other servicing should be performed by an authorized service representative.
- Close supervision is necessary when this product is used by, on, or near children or invalids.
- Do not dismantle, repair, or alter the unit.

2

IMPORTANT SAFEGUARDS

WARNING To reduce the risk of burns, electrocution, fire or injury to persons.

- Never use while sleeping or drowsy.
- Never drop or insert any object into any opening or hose.
- Do not use outdoors, or operate where aerosol(spray) products are being used or where oxygen is being administered.
- Do not pour or spray water on to the unit.
- Do not use steam cleaner.
- Keep the unit away from fires or inflammable substance.
- Do not connect to the industrial water supplies.
- Caution against low temperature burns.
- New hose-sets supplied with the appliance are to be used and that old hose-sets should not be reused.

CAUTION To reduce the risk of injury to persons or damage to the product or the property.

- Do not place heavy objects or step on the unit. It may cause product damage or injury.
- When cleaning the unit, do not use any harsh chemicals like bleach, ammonia or alcohol based cleaners. Clean the unit with warm water and mild soap. Natural disinfectants like vinegar may also be used. It may cause product damage and discoloration.
- Do not slam down the lid. It may cause product defect.
- Do not lean on the lid. It may cause product defect.
- When not in use for a long period of time (more than 2-3 months), disconnect the power plug and drain the water tank. Tank water may be contaminated and cause skin troubles.
- Do not twist or pull the connection hoses. It may affect water supply or cause water leakage.
- Do not cover up the warm air outlet or insert hands or other objects. It may cause burn or electric shock.
- Do not operate the unit during product malfunction. Disconnect the power plug and call the authorized service center. It may cause fire or electric shock if the unit is operated while it is out of order.

3

GROUNDING INSTRUCTIONS

WARNING Improper use of the grounding plug can result in risk of electric shock.

This product is for use with a 110/120v circuit and at least 15amps and a GFCI (ground fault circuit interrupter) outlet. Do not use this product with an ungrounded outlet.

GFCI outlets are required in waterborne environments (like bathrooms).

The product does not require a dedicated circuit.

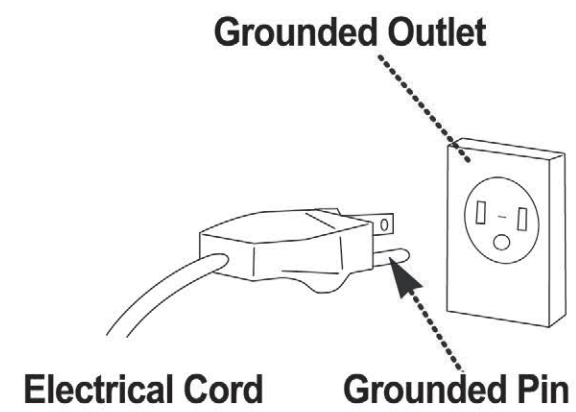

4

NAME OF PARTS



INSTALLATION

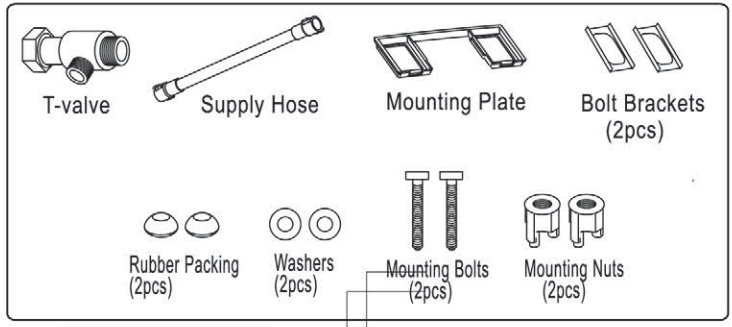

Installation Procedure

- Read the instructions carefully before installing.
- Plug in electrical cord only after the rest of installation is completed.

1 Shut-off water supply and disconnect the toilet supply hose.

- Close the shut-off valve at the wall. Flush toilet tank completely to empty it. Then, disconnect the toilet supply hose where it connects to the toilet tank fill valve, NOT at the shut-off valve.
- If your toilet is skirted and you cannot access the toilet's fill valve, contact us to purchase an alternate t-valve.

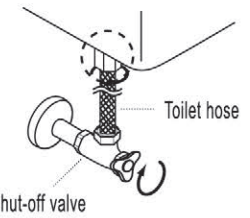

2 Remove the existing toilet seat

- Remove the old toilet seat. It's usually fastened via nuts underneath the bowl.
- It's a good idea to save your old toilet seat in case you need it again later.



3 Connect T-valve

- Install the T-valve to your toilet's fill valve underneath the tank, NOT at the shut-off valve.
- Ensure the rubber cone washer is present at the top and pointed up toward the toilet tank. This connection typically does not need teflon tape.
- Reconnect the toilet supply hose to the bottom of the T-valve



4 Lock the mounting plate into the seat.

- Place the Mounting Bolts into the Bolt Brackets as shown to the right.
- Position the bolts and brackets in the Mounting Plate as shown below. Slide the Mounting Plate with Bolts/Brackets into the rear of the bidet unit in the direction shown below.
- The Mounting Plate should slide into grooves on the underside of the bidet. Keep pushing it in until it locks into place with an audible click.

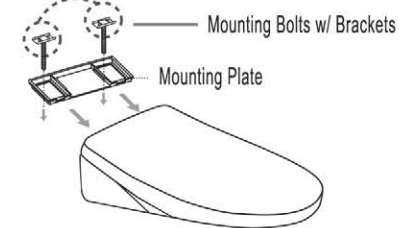

5 Install the bidet onto the toilet bowl.

- Pick up the bidet seat with mounting bolts protruding from the bottom. Place it onto your toilet bowl and align the bolts through the bolt holes of the bowl.
- Arrange the Rubber Packing, Washer, and Mounting Nut as shown to the right.
- From under the toilet bowl, fasten the Mounting Nuts to each Mounting Bolt as shown below. Be sure that the Rubber Packing and Washer are arranged on top of the nuts as shown.

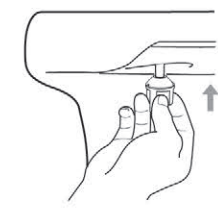
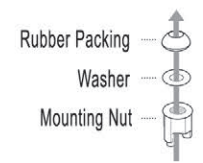

6 Connect the supply hose to the bidet.

- Connect the Supply Hose from the T-valve to the bidet inlet located underneath the side control panel.
- Once all connections are tight, slowly open the shut-off valve and check for leaks.
- If you find a leak, shut off the water. Make sure that all rubber washers and o-rings are properly seated. Re-tighten and then turn the water on again.

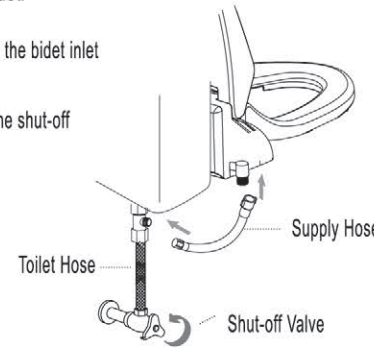

Operation check

- Connect the power plug into electrical outlet.
- Wait for the bidet to power on and run through startup cycle.
- Sit on the seat with skin contact. Test functions.
- Heated seat and warm water features will need a few minutes to heat up.

HOW TO USE

STOP

- Press Stop button when you want to stop any function.

REAR

- Press REAR button to activate a rear cleansing cycle.
- Press the button again during the cycle to make the nozzle oscillate back and forth.
- Press the button again, and the oscillation will stop.

REAR+

- Press REAR+ button to activate a more powerful rear cleansing cycle.
- It starts from the highest water pressure.

FRONT

- Press FRONT button to activate a front, feminine cleansing cycle.
- Press the button again during the cycle to make the nozzle oscillate back and forth.
- Press the button again, and the oscillation will stop.

DRY

- Press DRY button to activate a warm air drying cycle.
- The drying cycle will last for 3 minutes before stopping.

PULSE

- Press PULSE button during a cleansing cycle to make the water pressure pulse from strong to soft.
- Press the button again to stop the pulse function.

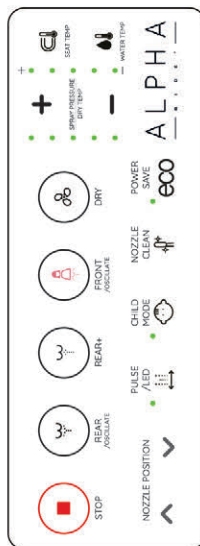

SPRAY PRESSURE / DRY TEMP

- 5 levels of Spray pressure/ Drying temperature.

NOZZLE POSITION

- Control Nozzle position forward or backward.

SEAT TEMP / WATER TEMP

- 5 levels of Water temperature / Seat temperature.

POWER SAVE

- Turning this feature on will reduce the water and seat temperatures to save power.

NOZZLE CLEAN

- Press the button to bring the nozzle out for manual cleaning.
- Press the button again, and the nozzle will retract.

CHILD MODE

- Turning this feature on will reduce spray pressure and allow the seat to spray with the seat sensor engaged.

ON / OFF

- Press the button to power ON or OFF

LED Nightlight

- Press PULSE button while not seated to toggle LED Nightlight feature.
- LED Nightlight will toggle between ON and OFF.

9

MAINTENANCE

Using the POWER SAVE Feature

- There are 2 power saving eco modes to save energy while the seat is idle.
- Press the button once to activate Mode 1 (green LED): This mode will maintain the selected water and seat temperatures for 30 minutes after standing up. After that, water heater will turn OFF, and seat temperature will reduce to 86F. Both water and seat heating will turn OFF if idle for 24 hours.
- Press the button twice to activate Mode 2 (red LED). This will turn both the water and seat heaters OFF until someone sits down.
- If a user sits down while either power saving mode is on, the water and seat heaters will turn on and work up to the preset temperatures. This will take about 5 minutes.
- When user stands up, the water heater and seat heaters will automatically return to power save mode.

IMPORTANT

- If you prefer a consistently warm seat and heated water each time you sit down, we would advise you to turn off the power saving modes.
- To turn off the power saving modes, press POWER SAVE until the LED is off.

Cleaning the Nozzle

■ Use a soft cloth or toothbrush to clean the nozzle.
■ Do not use abrasive, volatile, or acid/alkaline detergents and chemicals. It may corrode the nozzle.

Nozzle Clean (Automatic)

Press the NOZZLE CLEAN button while nobody is seated to activate a 2 minute automatic self cleaning function.

Nozzle Clean (Manual)

- Press and hold the NOZZLE CLEAN button while nobody is seated for 5 seconds. The nozzle will come out and stay out for manual cleaning.
- Brush the nozzle tip with a soft brush and wipe the nozzle with a cloth. Press STOP when done.

※ Do not pull out or push the nozzle forcibly.
※ Nozzle clean function does not work when seat occupied.



10

Removing the Bidet Seat

The seat release tab is a small tab on the underside of the unit (same side as electrical cord)

Press in and hold this seat tab to release the bidet seat from the catch plate. Slide whole unit forward toward front of bowl to remove.

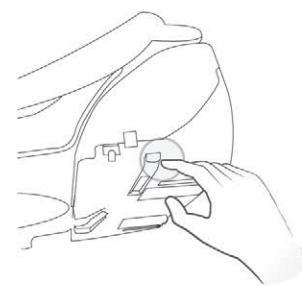

Screen Filter Cleaning

1 Close the water shut-off valve at the wall.
2 Disconnect the water supply hose. Take the screen filter out and clean it with a soft brush.
3 Return the filter after cleaning and reconnect the water supply hose.

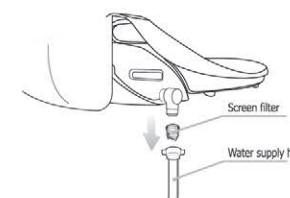

Cleaning of Unit Body

1 Exterior surface of unit is made of plastic material, which may be damaged by scrubber, chemicals, bleach, alcohol based cleaners, etc.
2 Wipe the surface with a soft damp cloth. Do not spray water directly onto the surface.
3 Be careful of not dropping any chemical detergents of toilet cleaner on the water supply hose. Risk of the hose damage.



Draining Water Tank

1 Unplug the bidet from the power outlet.
2 Close the water shut-off valve.
3 Press/hold the seat release tab and slide the unit forward and off the catch plate.
4 Use a coin to open the drain plug.

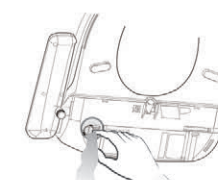

11

TROUBLESHOOTING

If you think the product is malfunctioning, refer to the following table to troubleshoot.

Power supply

Trouble	Possible Causes	Solution
The unit is not working	Is the power outlet active? Or is the circuit breaker off?	Wait until the power is restored. Or turn on the circuit breaker.
	Are the power indicator lights on the side control panel on?	Make sure unit is plugged in and press the on/off button on panel.

REAR, REAR+, and FRONT CLEANSING

Trouble	Possible Causes	Solution
Water pressure is weak	Is the water pressure set to a low level?	Adjust the water pressure to higher level.
	Is the inlet strainer clogged?	Clean the strainer.
Water is cold	Is the temperature set to a low level? Or is it turned off?	Adjust the water temp on the control panel.
	Is it in power save mode?	Turn off power saving modes and allow water to heat up.
Water spray stops during use.	All cleansing cycles will automatically stop after 90 seconds.	Press a wash function again to start a new cycle.
	Seat sensor not engaged	Make sure there's skin contact on the seat sensor.

12

Heated seat

Trouble	Possible Causes	Solution
The seat is not warm.	Is the seat temperature set to OFF or low level?	Raise the seat temperature on the control panel.
	Is the bidet in power save mode?	Turn off power saving models and allow seat to heat up.

Seat sensor

Trouble	Possible Causes	Solution
The wash functions work without anyone sitting on the seat.	Is the seat wet? Is there a moist cloth on the seat?	Dry the seat and/or remove the cloth.

Self diagnosis

Trouble	Indication (LED lamp on Temperature control)	Symptom
Water supply stops, or water level sensor faulty	3stage LED blinks	Water not spray, warm water not spray
Water temperature sensor disconnected	5stage LED blinks	Warm water not spray
Water temperature sensor short circuit	4stage LED blinks	All washing function not working
Seat temperature sensor disconnected	2stage LED blinks	Seat not heated
Seat temperature sensor short circuit	1stage LED blinks	Seat not heated

13

SPECIFICATIONS

Item	Description	
Model	Alpha GX-R Wave	
Power rating	AC120V 60Hz 864W	
Ambient temperature	0~104F	
Water supply	Direct water connection	
Water pressure req'd	15-106psi	
Wash	REAR wash	Max 0.7 L/Min
	FRONT wash	Max 0.8 L/Min
	REAR+ wash	Max 1 L/Min
	Heater capacity	800W
	Tank capacity	0.6L
	Water temperature	Room temp - 104F
Safety device	Thermal Fuse, Thermostat, Water Level Sensor	
Dryer	Heater capacity	250W
	Air temperature	Room temp - 131 F
	Safety device	Thermal Fuse
Heated seat	Heater capacity	55W
	Seat temperature	Room temp - 104F
Safety device	Thermal Fuse	
Power cord length	4 ft	
Product dimension	20.9" (L) x 18.7" (W) x 5.4"(H)	
Product weight	9.9lbs	

14

WARRANTY

ALPHA BIDET (WebGerms Health Inc) warrants the Alpha GXR Wave to be free from manufacturing defects under normal use and service for a period of one (1) year from the date of purchase from an authorized retailer.

This warranty is extended only to the ORIGINAL PURCHASER.

Our obligations under this warranty are limited to repair or replacement, at ALPHA BIDET's option, of products or parts found to be defective, provided that such products were properly installed and used in accordance with instructions. ALPHA BIDET reserves the right to make such inspections as may be necessary in order to determine the cause of the defect. ALPHA BIDET will not charge for labor or parts in connection with warranty repairs or replacements. WebGerms Health Inc is not responsible for the cost of installation, removal, return shipping and/or reinstallation of products.

This warranty does not apply to the following items:
Damage or loss sustained in a natural calamity such as fire, earthquake, flood, thunder electrical storm, etc.
Damage or loss resulting from any unreasonable use, misuse, abuse, negligence, or improper maintenance of the product.
Damage or loss resulting from removal, improper repair, or modification of the product.
Damage or loss resulting from sediments or foreign matter contained in a water system.
Damage or loss resulting from improper installation or from installation of a unit in a harsh and/or hazardous environment

This warranty gives you specific legal rights. You may have other rights which vary from state to state. To obtain warranty repair service under this warranty, you must take the product or deliver it prepaid to our service facility together with a letter stating the problem, or contact a distributor or products service contractor, or write directly to 2550 Corporate PI STE C100 Monterey Park, CA 91754.

This written warranty is the only warranty made by ALPHA BIDET. Repair or replacement as provided under this warranty shall be the exclusive remedy available to the purchaser. We shall not be responsible for loss of the product or for other incidental, special or consequential damages or expenses incurred by the purchaser, or for labor or other costs due to installation or removal, or costs of repairs by others, or for any other expense not specifically stated above. Except to the extent prohibited by applicable law, any implied warranties, including that of merchantability or fitness for use, are expressly limited to the duration of this warranty. Some states do not allow limitations on how long an implied warranty lasts, or the exclusion or limitation of incidental or consequential damages, so the above limitation and exclusion may not apply to you.

Warning! We shall not be responsible or liable for any failure of, or damage to, this plumbing product or product component caused by either chloramines in the treatment of public water supply or in-tank bowl cleaners containing bleach, alcohol, or chlorine (calcium hypochlorite).

Note: The use of high concentration of chlorine or chlorine related products can seriously damage the fittings. This damage can cause leakage and serious property damage.

15

GXR Wave

ALPHA BIDET

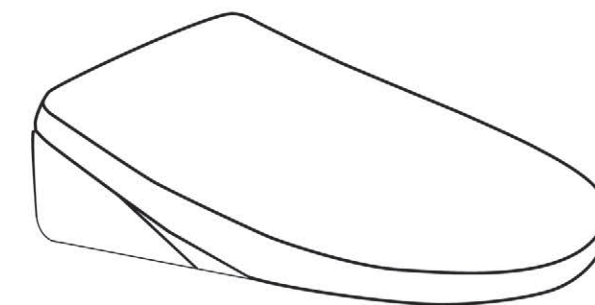

Customer Service: support@alphabidet.com

ALPHA

B I D E T

ALPHA BIDET | WebGerms Health Inc
2550 Corporate PI Ste C100
Monterey Park, CA 91754